

Pressure switch MDR 3

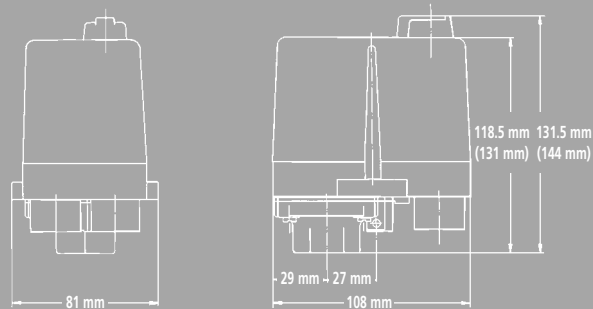

3-phase; Switching capacity 7.5 (11) KW
available with overload relay
max. cut-out pressure 35 bar



TYPES

3-pole (N.C.)

Order reference	ON / OFF Switchknob	Pressure range P _{OFF} (bar)	Flange	Weight (g)	Part No.
MDR-3 DAA AAAA 045A060 XAA XXX	EA	1.3 - 6	1/2"	610	212256
MDR-3 GAA AAAA 090A110 XAA XXX	EA	4 - 11	1/2"	610	212263
MDR-3 GBA AAAA 090A110 XAA XXX	EA	4 - 11	1/4"	610	212270
MDR-3 GEA AAAA 090A110 XAA XXX	EA	4 - 11	F4 1/4"	640	212287
MDR-3 GDA AAAA 090A110 XAA XXX	EA	4 - 11	F4 1/2"	640	212294
MDR-3 GFA AAAA 090A110 XAA XXX	EA	4 - 11	F4 3/8"	640	212300
MDR-3 HAA AAAA 130A160 XAA XXX	EA	6 - 16	1/2"	610	212317
MDR-3 HBA AAAA 130A160 XAA XXX	EA	6 - 16	1/4"	610	212324
MDR-3 HEA AAAA 130A160 XAA XXX	EA	6 - 16	F4 1/4"	640	212331
MDR-3 HDA AAAA 130A160 XAA XXX	EA	6 - 16	F4 1/2"	640	212348
MDR-3 HFA AAAA 130A160 XAA XXX	EA	6 - 16	F4 3/8"	640	212355
MDR-3 IAA AAAA 215A250 XAA XXX	EA	7.5 - 25	1/2"	610	212362
MDR-3 IDA AAAA 215A250 XAA XXX	EA	7.5 - 25	F4 1/2"	640	212379
MDR-3 JAA AAAA 320A350 XAA XXX	EA	12 - 35	1/2"	610	229711
MDR-3 JDA AAAA 320A350 XAA XXX	EA	12 - 35	F4 1/2"	640	229728
MDR-3 DAA BAAA 045A060 XAA XXX	-	1.3 - 6	1/2"	590	226932
MDR-3 GAA BAAA 090A110 XAA XXX	-	4 - 11	1/2"	590	226949
MDR-3 GBA BAAA 090A110 XAA XXX	-	4 - 11	1/4"	590	226956
MDR-3 GEA BAAA 090A110 XAA XXX	-	4 - 11	F4 1/4"	620	226963
MDR-3 GDA BAAA 090A110 XAA XXX	-	4 - 11	F4 1/2"	620	226970
MDR-3 GFA BAAA 090A110 XAA XXX	-	4 - 11	F4 3/8"	620	226987
MDR-3 HAA BAAA 130A160 XAA XXX	-	6 - 16	1/2"	590	226994
MDR-3 HBA BAAA 130A160 XAA XXX	-	6 - 16	1/4"	590	227007
MDR-3 HEA BAAA 130A160 XAA XXX	-	6 - 16	F4 1/4"	620	227014
MDR-3 HDA BAAA 130A160 XAA XXX	-	6 - 16	F4 1/2"	620	227021
MDR-3 HFA BAAA 130A160 XAA XXX	-	6 - 16	F4 3/8"	620	227038
MDR-3 IAA BAAA 215A250 XAA XXX	-	7.5 - 25	1/2"	590	227045
MDR-3 IDA BAAA 215A250 XAA XXX	-	7.5 - 25	F4 1/2"	620	227052
MDR-3 JAA BAAA 320A350 XAA XXX	-	12 - 35	1/2"	590	229698
MDR-3 JDA BAAA 320A350 XAA XXX	-	12 - 35	F4 1/2"	620	229704

Unloader valves and cable glands for retrofit assembly to be ordered separately, see Accessories!

with roller diaphragm
tight pressure differential
extended medium compatibility
3-pole (N.C.)

Order reference	ON / OFF Switchknob	Pressure range P _{OFF} (bar)	Successor model to	Flange	Weight (g)	Part No.
MDR-3 DAB BAAA 028A035 XAA XXX	-	1 - 6	-	1/2"	770	229674
MDR-3 GAB BAAA 060A070 XAA XXX	-	3 - 10	MDR 6/11-1/2"	1/2"	770	227595
MDR-3 GOB BAAA 060A070 XAA XXX	-	3 - 10	MDR 6/11-1/2"+1/4"	1/2"+1/4"	810	227601
MDR-3 GAB AAAA 060A070 XAA XXX	EA	3 - 10	MDR 6/11 K-1/2"	1/2"	800	227632
MDR-3 GOB AAAA 060A070 XAA XXX	EA	3 - 10	MDR 6/11 K-1/2"+1/4"	1/2"+1/4"	850	227649
MDR-3 HAB BAAA 145A160 XAA XXX	-	5 - 16	MDR 6/16-1/2"	1/2"	770	227618
MDR-3 HOB BAAA 145A160 XAA XXX	-	5 - 16	MDR 6/16-1/2"+1/4"	1/2"+1/4"	810	227625
MDR-3 HAB AAAA 145A160 XAA XXX	EA	5 - 16	MDR 6/16 K-1/2"	1/2"	800	227656
MDR-3 HOB AAAA 145A160 XAA XXX	EA	5 - 16	MDR 6/16 K-1/2"+1/4"	1/2"+1/4"	850	227663

Unloader valves and cable glands for retrofit assembly to be ordered separately, see Accessories!

Pressure switch MDR 3



TYPES

with ON/OFF switchknob
and overload relay
3-pole (N.C.)

Order reference	Overload relay	Pressure range P _{OFF} (bar)	Flange	Weight (g)	Part No.
MDR-3 DAA AAAA 045A060 XAA GXX	4.0 A	1.3 - 6	1/2"	630	212386
MDR-3 DAA AAAA 045A060 XAA HXX	6.3 A	1.3 - 6	1/2"	630	212393
MDR-3 DAA AAAA 045A060 XAA IXX	10.0 A	1.3 - 6	1/2"	630	212409
MDR-3 DAA AAAA 045A060 XAA JXX	16.0 A	1.3 - 6	1/2"	630	212416
MDR-3 DAA AAAA 045A060 XAA KXX	20.0 A	1.3 - 6	1/2"	630	212423
MDR-3 GDA AAAA 090A110 XAA GXX	4.0 A	4 - 11	F4 1/2"	660	212430
MDR-3 GDA AAAA 090A110 XAA HXX	6.3 A	4 - 11	F4 1/2"	660	212447
MDR-3 GDA AAAA 090A110 XAA IXX	10.0 A	4 - 11	F4 1/2"	660	212454
MDR-3 GDA AAAA 090A110 XAA JXX	16.0 A	4 - 11	F4 1/2"	660	212461
MDR-3 GDA AAAA 090A110 XAA KXX	20.0 A	4 - 11	F4 1/2"	660	212478
MDR-3 HDA AAAA 130A160 XAA GXX	4.0 A	6 - 16	F4 1/2"	660	212485
MDR-3 HDA AAAA 130A160 XAA HXX	6.3 A	6 - 16	F4 1/2"	660	212492
MDR-3 HDA AAAA 130A160 XAA IXX	10.0 A	6 - 16	F4 1/2"	660	212508
MDR-3 HDA AAAA 130A160 XAA JXX	16.0 A	6 - 16	F4 1/2"	660	212515
MDR-3 HDA AAAA 130A160 XAA KXX	20.0 A	6 - 16	F4 1/2"	660	212522
MDR-3 IDA AAAA 215A250 XAA GXX	4.0 A	7.5 - 25	F4 1/2"	660	212539
MDR-3 IDA AAAA 215A250 XAA HXX	6.3 A	7.5 - 25	F4 1/2"	660	212546
MDR-3 IDA AAAA 215A250 XAA IXX	10.0 A	7.5 - 25	F4 1/2"	660	212553
MDR-3 IDA AAAA 215A250 XAA JXX	16.0 A	7.5 - 25	F4 1/2"	660	212560
MDR-3 IDA AAAA 215A250 XAA KXX	20.0 A	7.5 - 25	F4 1/2"	660	212577

Unloader valves and cable glands for retrofit assembly to be ordered separately, see Accessories!

TECHNICAL DATA

acc. to EN 60947
UL / CSA

Rated insulation voltage U _i	690 V
Motor switching capacity (UL 508, CSA 22.2) U _e = 120 V (1~)	2 HP
Motor switching capacity (UL 508, CSA 22.2) U _e = 240 V (1~)	5 HP
Motor switching capacity (AC 3) U _e = 230 V (1~)	5.5 kW
Motor switching capacity (AC 3) U _e = 230 V (3~)	5.5 kW
Motor switching capacity (UL 508, CSA 22.2) U _e = 240 V (3~)	7.5 HP
Motor switching capacity (AC 3) U _e = 400 V (3~)	7.5/11* kW
Motor switching capacity (UL 508, CSA 22.2) U _e = 480 V (3~)	15 HP
Motor switching capacity (AC 3) U _e = 500 V (3~)	7.5/11* kW
Motor switching capacity (UL 508, CSA 22.2) U _e = 600 V (3~)	20 HP
Motor switching capacity (AC 3) U _e = 690 V (3~)	7.5/15* kW

* with contact block SK-... H on request

Electrical life (AC 3) Cycles	> 1 x 10 ⁵
Mechanical life Cycles	> 1 x 10 ⁶
Max. electrical cycles Cycles/h	120
Max. mechanical cycles Cycles/h	600
Rated operating current I _e at 240 V AC	24 A
Bursting strength P _z	≤ 16 ≥ 25 bar > 40 > 60 bar
Permissible medium temperature Air	-5...+ 80 °C
Permissible medium temperature Water	+ 80 °C
Protection acc. to EN 60529	IP 54
Conductor cross-section 1 ... flexible cable 1 x / 2 x	4 / 2.5 mm ²
Conductor cross-section 1 ... rigid cable 1 x / 2 x	6 / 4 mm ²

Pressure switch MDR 3



DIAPHRAGM MEDIA RESISTANCE

Standard
resistance Air · Water
limited resistance Hydrous lye solutions · Hydrous acids Motor oils
non-resistance Fuels · Hydrogen halides Ester · Ketone

MDR 3 RM
resistance Acetylene · Alcohol · Natural gas · Crude oil · Vinegar · Fats Mineral oils · Anti-freezing agent · Glycol · Marsh gas Carbon oxide · Carbon dioxide · Laughing gas · Air (clean, oily) Methane · Propane · Testing media ASTM I · Silicon oils · Water Hydrogen
limited resistance Sodium chloride · Butane · Sea water · Motor oils Roasting gases · Washing powder
non-resistance Ammonia · Nitroglycerine Sulfur dioxide

TRIPPING CURVES

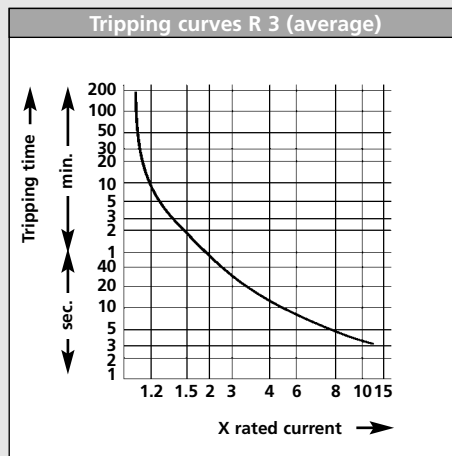

ACCESSORIES

Hourmeter kit

Description
The MDR 3 can be equipped or retrofitted with an operating hourmeter to monitor the pump and compressor running time. The hourmeter is available as a kit and can be attached to the cover in 4 different positions, each offset at an angle of 90°. This ensures optimum readability. The kit consists of an operating hourmeter for either 230 V or 400 V and a perforated MDR 3 cover with or without ON/OFF switch.

TYPES

Hourmeter kit

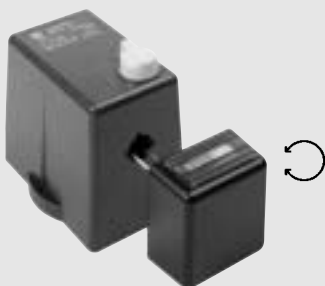

Order reference	Description	Voltage	Packing (units)	Part No.
H3 - B 230	Hourmeter and Cover for MDR-3	230 V / 50 Hz	1	237297
H3 - B 400	Hourmeter and Cover for MDR-3	400 V / 50 Hz	1	237303
H3-EA - B 230	Hourmeter and Cover for MDR-3+EA	230 V / 50 Hz	1	237310
H3-EA - B 400	Hourmeter and Cover for MDR-3+EA	400 V / 50 Hz	1	237327

Pressure switch MDR 3



ACCESSORIES



AEV 3 S



AEV 3

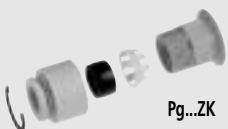

Pg...ZK

Order reference	Description	Weight (g)	Part No.
Unloader valves			
EV 3	with screw fitting for 6 mm plastic or copper discharge line	25	201045
EV 3i	with screw fitting for 1/4" plastic or copper discharge line	25	201052
EV 3S **	with quick-connect for 6 mm plastic discharge line	25	201069
EV 3-W **	(right-angle) with screw fitting for 6 mm plastic or copper discharge line	18	201076
EV 3 -WS **	(right-angle) with quick-connect for 6 mm plastic discharge line	10	201090
Unloader valves for difficult motor starting conditions			
AEV 3	with screw fitting for 6 mm plastic or copper discharge line	25	201106
AEV 3S **	with quick-connect for 6 mm plastic discharge line	25	201120
AEV 3-WS **	(right-angle) with quick-connect for 6 mm plastic discharge line	18	201151
Cable glands			
WN	Cable grommets	6	201243
PG 9 Z	with strain relief	12	201373
PG 11 G	conduit	6	201250
PG 11 V	complete	12	201267
PG 11 Z	with strain relief	12	201274
PG 11 ZK	with strain relief and cable support	12	201281
PG 13.5 G	conduit	6	201298
PG 13.5 V	complete	12	201304
PG 13.5 Z	with strain relief	12	201311
PG 13.5 ZK	with strain relief and cable support	12	201328
PG 16 G	conduit	6	201335
PG 16 V	complete	12	201342
PG 16 Z	with strain relief	12	201359
PG 16 ZK	with strain relief and cable support	18	201366
MW	Wall-mounting adapter	65	230021
Cover			
H3 (Cover MDR 3)	Cover without rotary knob	100	229490
H3-EA (Cover MDR 3+EA)	Cover with rotary knob for manual ON/OFF switching	100	230007
Thermal, 3-pole overload relay			
SK 3	Contact block without lock mechanism (supplied as standard with MDR 3...)	90	201380
SK 3-S	Contact block with lock mechanism (supplied as standard with MDR 3...+EA)	110	201397
SK R3/ 1.0	0.63 - 1.00 A	145	201403
SK R3/ 1.6	1.00 - 1.60 A	145	201410
SK R3/ 2.5	1.60 - 2.50 A	145	201427
SK R3/ 4.0	2.50 - 4.00 A	145	201434
SK R3/ 6.3	4.00 - 6.30 A	145	201441
SK R3/ 10.0	6.30 - 10.00 A	145	201458
SK R3/ 16.0	10.00 - 16.00 A	145	201465
SK R3/ 20.0	16.00 - 20.00 A	145	201472
SK R3/ 24.0	20.00 - 24.00 A	145	201489
SK R3/ 30/2	22.00 - 30.00 A, 2-pole	145	201496
SK R3H/ 16.0	10.00 - 16.00 A (H type for higher switching capacity)	145	201502
SK R3H/ 20.0	16.00 - 20.00 A (H type for higher switching capacity)	145	201519
SK R3H/ 24.0	20.00 - 24.00 A (H type for higher switching capacity)	145	201526
Undervoltage- and shunt releases*			
RU 3/230-50	Undervoltage release 230 V, 50 Hz	100	201540
RU 3/400-50	Undervoltage release 400 V, 50 Hz	100	201557
RA 3/480-60	Shunt release 480 V, 60 Hz	100	201595
RA 3/240-60	Shunt release 240 V, 60 Hz	100	214113
RA 3/24-50	Shunt release 24 V, 50 Hz	100	201564
RA 3/110-50	Shunt release 110 V, 50 Hz	100	201571
RA 3/230-50	Shunt release 230 V, 50 Hz	100	201588

* other voltages on request / ** up to ≤ 16 bar / Packing: 1 piece

Pressure switch MDR 3



DIMENSIONS ACCESSORIES

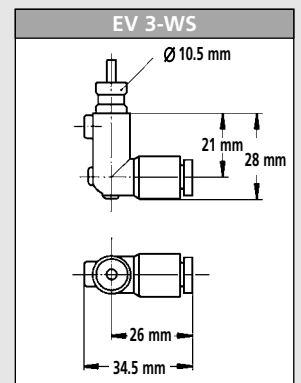
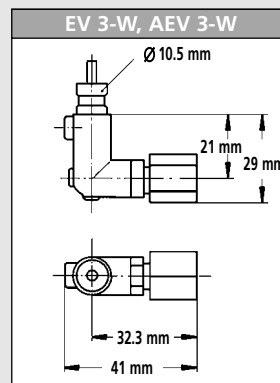
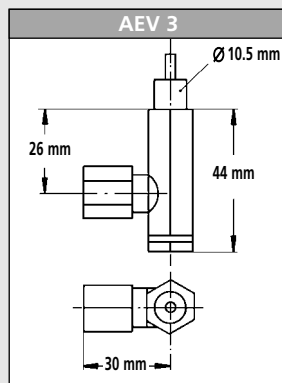
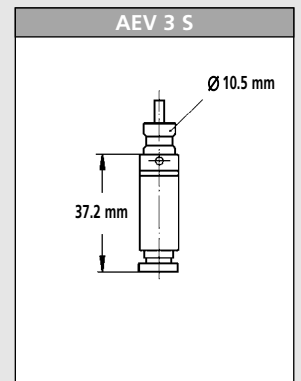
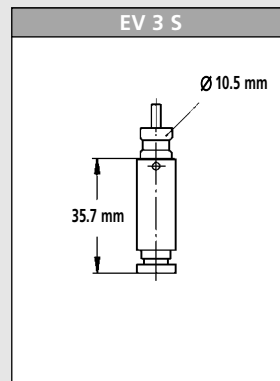
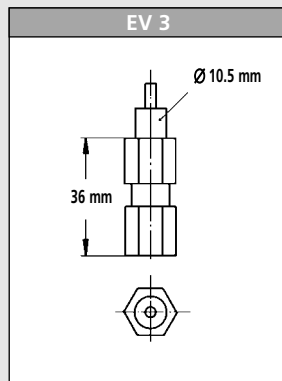

CIRCUIT DIAGRAMS

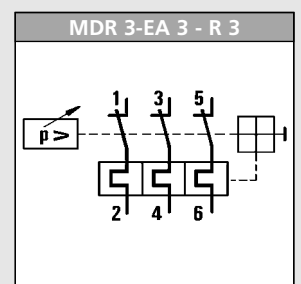
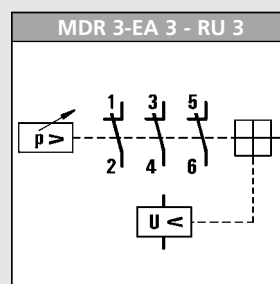
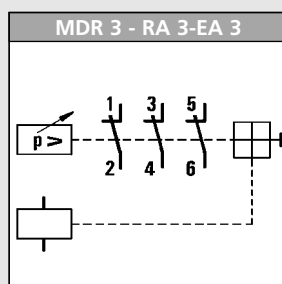
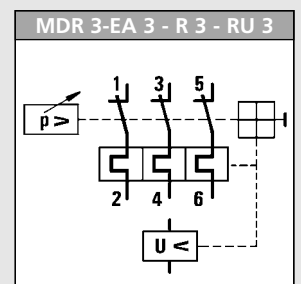
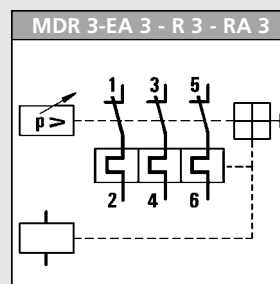
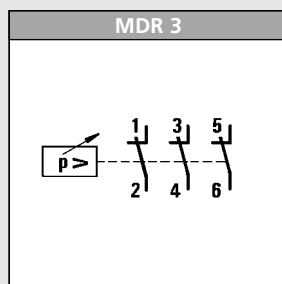

Pressure switch MDR 3



PRESSURE DIAGRAMS

